

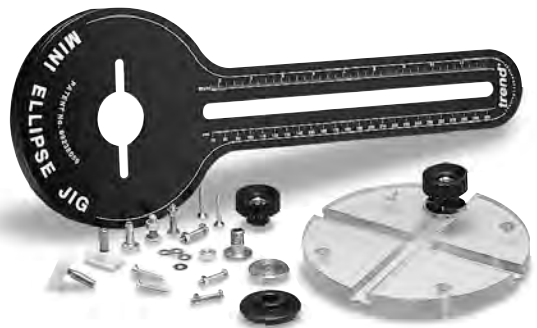

MINI ELLIPSE JIG



trend[®]
routing technology



Please read these instructions before use.

Dear Customer

Thank you for purchasing this Trend product, we hope you enjoy many years of creative and productive use.

Please remember to return your guarantee card within 28 days of purchase.

CONTENTS

TECHNICAL DATA	1
SAFETY	2-3
ITEMS ENCLOSED	4
DESCRIPTION OF PARTS & ASSEMBLY	5
- Mounting Router	6
- Ellipse & Circle Sizes	6
- Screw Sizes Required	7
OPERATION	
- Basic Setting up Procedure	8
- Marking Out	8
- Fixing Cross Frame	8
- Setting Major Axis	8
- Setting Minor Axis	9
- Fixing Methods	9
- Choice of Material	9
- Routing Operation	9
- Circle Cutting	10
- Suitable Cutters & Methods of Working	10
- Producing a Natural Timber Frame	11
- Producing an Elliptical Plaque in MDF	13
MAINTENANCE	14
ENVIRONMENTAL PROTECTION	14
GUARANTEE	14
SPARE PARTS	
- Spare Parts List	15
- Spare Parts Diagram	16

TECHNICAL DATA

Ellipse size:	max.	580mm x 430mm
	min.	220mm x 160mm
Circle size:	max.	600mm
	min.	160mm
Weight		1.1kg

The following symbols are used throughout this manual:



Denotes risk of personal injury, loss of life or damage to the tool in case of non-observance of the instructions in this manual.



Refer to the instruction manual of your power tool.

This unit must not be put into service until it has been established that the power tool to be connected to this unit is in compliance with 2006/42/EC (identified by the CE marking on the power tool).

INTENDED USE

This jig is intended for use with a router fitted with a suitable router cutter to rout ellipses and circles in timber and manmade boards.



If you require further safety advice, technical information or spare parts, please call Trend Technical Support or visit www.trend-uk.com

SAFETY



WARNING:

Observe the safety regulations in the instruction manual of the power tool to be used. Please read the following instructions carefully. Failure to do so could lead to serious injury. When using electric tools, basic safety precautions, including the following should always be followed to reduce the risk of fire, electric shock and personal injury. Also observe any applicable additional safety rules. Read the following safety instructions before attempting to operate this product.

PLEASE KEEP THESE INSTRUCTIONS IN A SAFE PLACE.

The attention of UK users is drawn to The Provision and Use of Work Equipment Regulations 1998, and any subsequent amendments.

Users should also read the HSE/HSC Safe Use of Woodworking Machinery Approved Code of Practice and Guidance Document and any amendments.

Users must be competent with woodworking equipment before using our products.

IMPORTANT NOTE:

Residual Risk. Although the safety instructions and operating manuals for our tools contain extensive instructions on safe working with power tools, every power tool involves a certain residual risk which cannot be completely excluded by safety mechanisms. Power tools must therefore always be operated with caution!

General

1. Disconnect power tool and attachment from power supply when not in use, before servicing, when making adjustments and when changing accessories such as cutters. Ensure switch is in "off" position. Always ensure cutter has stopped rotating.
2. Always mount the power tool, accessory or attachment in conformity with the instructions. Only use attachment and accessories specified in the power tool manual. The tool or attachment should not be modified or used for any application other than that for which it was designed. Do not force tool.
3. Keep children and visitors away. Do not let children or visitors touch the tool, accessory or attachment. Keep children and visitors away from work area. Make the workshop child proof with padlock and master switch.
4. Dress properly. Do not wear loose clothing or jewellery, they can be caught in moving parts. Rubber gloves and non-skid footwear is recommended when working

outdoors. Wear protective hair covering to contain long hair.

5. Consider working environment. Do not use the product in the rain or in a damp environment. Keep work area well lit. Do not use power tools near gasoline or flammable liquids. Keep workshop at a comfortable temperature so your hands are not cold. Connect machines that are used in the open via a residual current device (RCD) with an actuation current of 30 mA maximum. Use only extension cables that are approved for outdoor use.
6. The accessory or attachment must be kept level and stable at all times.
7. Keep work area clean. Cluttered workshops and benches can cause injuries. Ensure there is sufficient room to work safely.
8. Secure idle tools. When not in use, tools should be stored in a dry and high or locked up place, out of reach of children.
9. For best control and safety use both hands on the power tool and attachment. Keep both hands away from cutting area. Always wait for the spindle and cutter to stop rotating before making any adjustments.
10. Always keep guards in place and in good working order.
11. Remove any nails, staples and other metal parts from the workpiece.
12. Maintain tools and cutters with care. Keep cutters sharp and clean for better and safer performance. Do not use damaged cutters. Follow instructions for lubricating and changing accessories. Keep handles dry, clean and free from oil and grease.
13. Maintain accessories. Do not use damaged accessories. Only use accessories recommended by the manufacturer.
14. Check damaged parts. Before operation inspect the attachment, the power tool, the cable, extension cable and the plug carefully for signs of damage. Check for alignment of moving parts, binding, breakage, mounting and any other conditions that may effect its operation. Have any damage repaired by an Authorised Service Agent before using the tool or accessory. Protect tools from impact and shock.
15. Do not use tool if switch does not turn it on or off. Have defective switches replaced by an Authorised Service Agent
16. Don't over reach. Keep proper footing and balance at all times. Do not use awkward or uncomfortable hand

positions.

17. Don't abuse the cable. Never carry power tool or accessory by cord or pull it to disconnect from the socket. Keep cord from heat, oil and sharp edges. Always trail the power cord away from the work area.
18. Connect dust extraction equipment. If devices are provided for the connection of dust extraction and collection facilities, ensure these are connected and properly used.
19. Check all fixing and fastening nuts, bolts and screws on power tool, attachment and cutting tools before use to ensure they are tight and secure. Periodically check when machining over long periods.
20. Stay alert. Watch what you are doing. Use common sense. Do not operate tools when you are tired, under the influence of drugs or alcohol.
21. Personal Protective Equipment (PPE) for eye, ear and respiratory protection must be worn. All PPE must meet current UK and EU legislation.
22. Do not leave tools running unattended. Do not leave tool until it comes to a complete stop.
23. Always clamp workpiece being machined securely.
24. Only use cutting tools for woodworking that meet EN847-1/2 safety standards, and any subsequent amendments.
25. Vibration levels. Hand held power tools produce different vibration levels. You should always refer to the specifications and relevant Health & Safety Guide.

Routing Safety

1. Read and understand instructions supplied with power tool, attachment and cutter.
2. Keep hands, hair and clothing clear of the cutter.
3. Remove adjusting keys and spanners. Check to see that keys and adjusting spanners are removed from the router tool, cutter and attachment before turning router on. Make sure cutter can rotate freely.
4. Noise. Take appropriate measures for the protection of hearing if the sound pressure of 85dB(A) is exceeded. Routing sound pressure may exceed 85dB(A), so ear protection must be worn.
5. Eye protection. Always wear eye protection in the form of safety goggles, spectacles or visors to protect the eyes.
6. Respiratory protection. Wear a face or dust mask, or powered respirator.

Dust masks/filters should be changed regularly.

7. Do not switch router on with the cutter touching the workpiece. At the end of the cut, release the router plunge and allow spindle to stop rotating. Never use the spindle lock as a brake
8. The direction of routing must always be opposite to the cutter's direction of rotation. Do not back-cut or climb-cut.
9. Check before cutting that there are no obstructions in the path of the router. Ensure there are no obstacles beneath workpiece when cutting full thickness, and that a sacrificial work surface is used.

Router Cutter Safety

1. Cutting tools are sharp. Care should be taken when handling them. Do not drop cutters or knock them against hard objects. Handle very small diameter cutters with extra care. Always return cutter to its packaging after use.
2. Always use cutters with a shank diameter corresponding to the size of the collet installed in your tool.
3. The maximum speed (n.max) marked on the tool, or in instructions or on packaging shall not be exceeded. Where stated the speed range shall be adhered to. Recommended speeds are shown in the Trend Routing Catalogue and/or website.
4. Always use router cutters in a router. Drill and boring bits must not be used in a router. Router cutters must only be used for the material cutting application for which they are designed. Do not use on metal or masonry.
5. Never use cutters with a diameter exceeding the maximum diameter indicated in the technical data of the powertool or attachment used.
6. Before each use check that the cutting tool is sharp and free from damage. Do not use the cutting tool if it is dull, broken or cracked or if in any other damage is noticeable or suspected.
7. Cutters should be kept clean. Resin build up should be removed at regular intervals with Resin Cleaner[®]. The use of a PTFE dry lubricant will reduce resin build up. Do not use PTFE spray on plastic parts.
8. When using stacked tooling (multi-blade, block and groover etc.) on a spindle arbor, ensure that the cutting edges are staggered to each other to reduce the cutting impact.
9. Cutter shanks should be inserted into the collet all the way to the line indicated on the shank. This ensures that at least ¾ of the shank length is held in the collet. Ensure clamping

surfaces are cleaned to remove dirt, grease, oil and water.

10. Observe the correct assembly and fitting instructions in the router instruction manual for fitting the collet, nut and cutter.
11. Tool and tool bodies shall be clamped in such a way that they will not become loose during operation. Care shall be taken when mounting cutting tools to ensure that the clamping is by the shank of the cutting tool and that the cutting edges are not in contact with each other or with the clamping elements.
12. It is advisable to periodically check the collet and collet nut. A damaged, worn or distorted collet and nut can cause vibration and shank damage. Do not over-tighten the collet nut
13. Do not take deep cuts in one pass; take several shallow or light passes to reduce the side load applied to the cutter and router. Too deep a cut in one pass can stall the router.
15. In case of excessive vibrations whilst using the router stop immediately and have the eccentricity of the router, router cutter and clamping system checked by competent personnel
15. All fastening screws and nuts should be tightened using the appropriate spanner or key and to the torque value provided by the manufacturer.
16. Extension of the spanner or tightening using hammer blows shall not be permitted.
17. Clamping screws shall be tightened according to instructions provided by the manufacture. Where instructions are not provided, clamping screws shall be tightened in sequence from the centre outwards.

Using Routers In A Fixed Position

1. Attention should be made to the HSE's Safe Use of Vertical Spindle Moulding Machines Information Sheet No.18 and any revisions.
2. After work, release the router plunge to protect the cutter.
3. Always use a push-stick or push-block when making any cut less than 300mm in length or when feeding the last 300mm of the cut.
4. The opening around the cutter should be reduced to a minimum using suitably sized insert rings in the table and closing the back fence cheeks or fitting a false fence on the back fence.
5. Whenever possible use a work holding device or jig to secure component being machined. Ensure any attachment is securely fitted to the workbench, with table surface at

approximately hip height.

6. Use a No-Volt Release Switch. Ensure it is fixed securely, easily accessible and used correctly.
7. In router table (inverted) mode, stand to the front right of the table. The cutter will rotate anti-clockwise when viewed from top so the feed direction is from the right (against the rotation of the cutter). In overhead mode, stand to the front left of the machine table and the feed direction is from the left.
8. Do not reach underneath table or put your hands or fingers at any time in the cutting path while tool is connected to a power supply.
9. Never thickness timber between the back of the cutter and the backfence.

Useful Advice When Routing

1. Judge your feed rate by the sound of the motor. Feed the router at a constant feed rate. Too slow a feed rate will result in burning.
2. Trial cuts should be made on waste material before starting any project.
3. When using some attachments e.g. a router table or dovetail jig, a fine height adjuster is recommended.
4. When using a template guide bush, ensure there is sufficient clearance between cutter tip and inside edge of bush and that it cannot come into contact with collet and nut. Ensure cutter and guide bush are concentric.

Router Cutter Repair/Maintenance

1. Repair of tools is only allowed in accordance with the manufacturers instructions.
3. The design of composite (tipped) tools shall not be changed in process of repair. Composite tools shall be repaired by a competent person i.e. a person of training and experience, who has knowledge of the design requirements and understands the levels of safety to be achieved.
4. Repair shall therefore include, e.g. the use of spare parts which are in accordance with the specification of the original parts provided by the manufacturer.
5. Tolerances which ensure correct clamping shall be maintained.
6. Care shall be taken that regrinding of the cutting edge will not cause weakening of the body and the connection of the cutting edge to the body.

Version 7.1 06/2006

ITEMS ENCLOSED

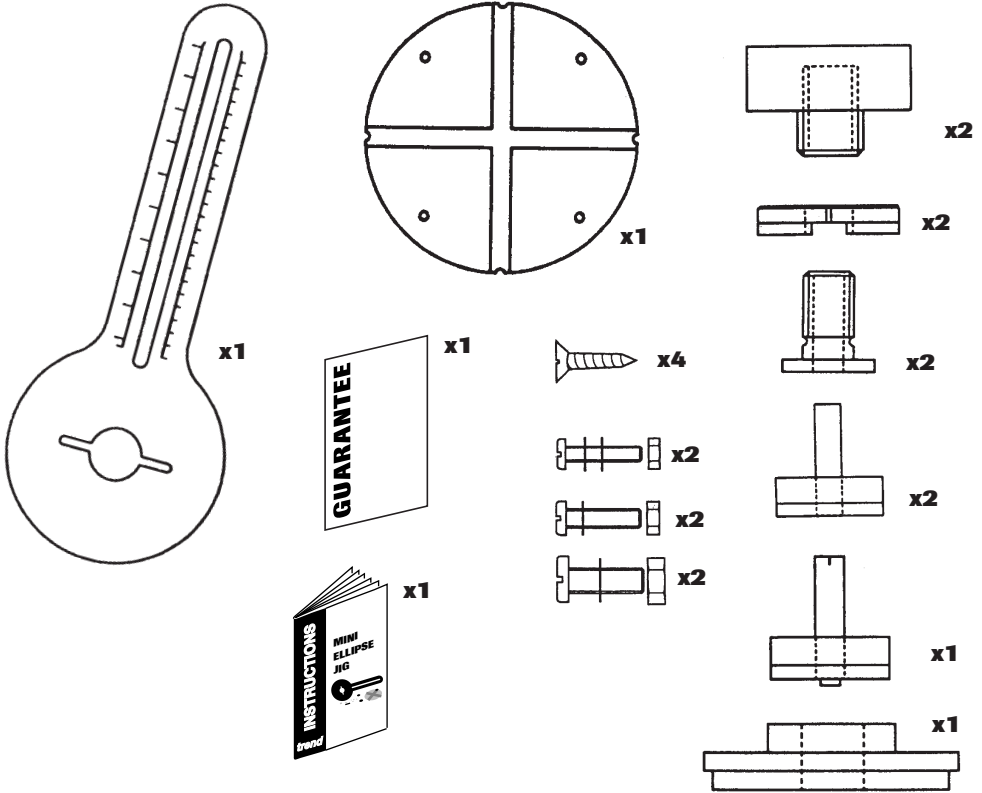

ITEMS REQUIRED

- Router.
- Hand Tools.
- Suitable router cutter.
- Pencil.

The following table shows limitations of sizes for ellipses it is possible to make.

DESCRIPTION OF PARTS & ASSEMBLY

Use the diagram below as a guide to assembling the jig.

- (A) Main plate (F) Ellipse slider
- (B) Cross frame (G) Circle slider
- (C) Securing knob (H) Pen plug & grommet
- (D) Index washer (I) Mounting screws
- (E) Index sleeve (J) Mounting kit for router

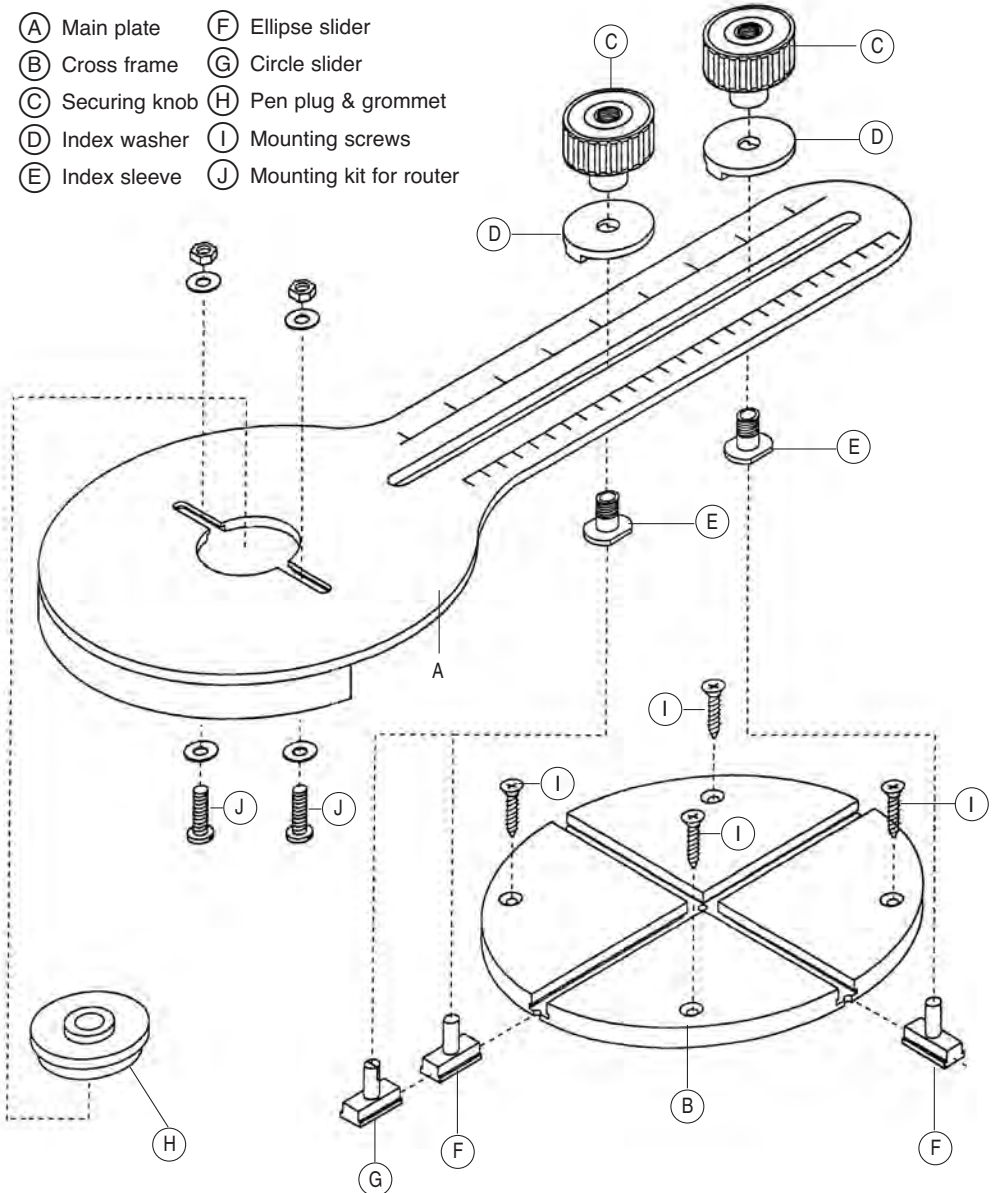

Mounting Router



Fixing screws are provided for mounting the router to the router plate. See chart for correct selection. Ensure router spindle is central with central hole in main plate. Slots are provided in main plate to allow for the various positions of the fixing points on the router base.

Certain router models will require additional nuts and washers. The position of the router will vary according to it's design. The removal of one of the handles may be necessary with certain models that require an 'in line' position.



Please do not over-tighten fixing bolts when fitting the router to the router plate.

Mounting Position of Routers

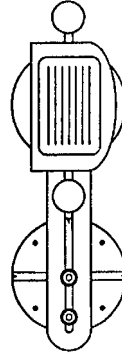

'In Line'

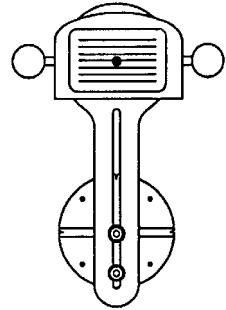

At 90°

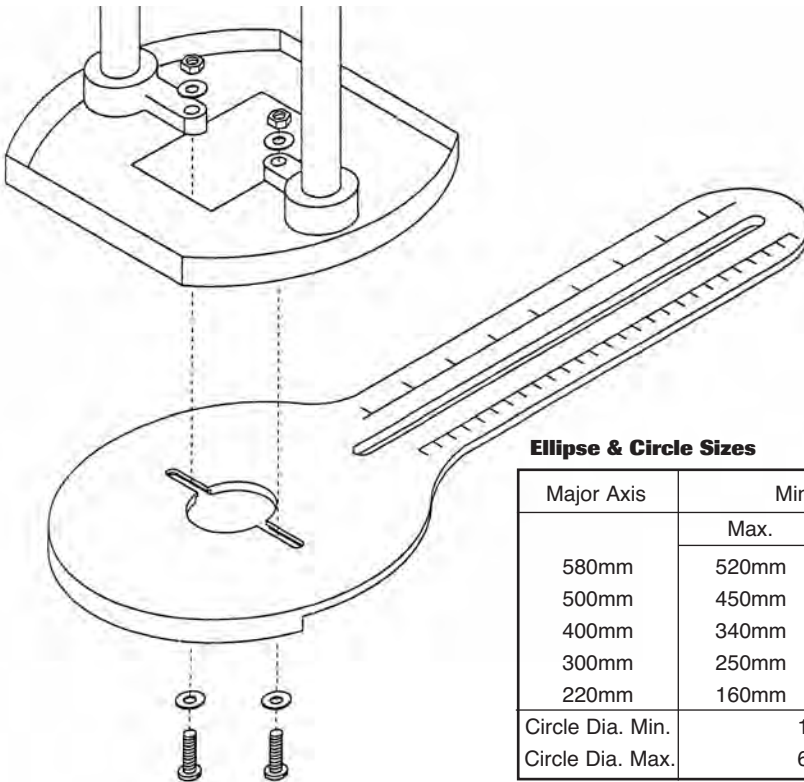

Ellipse & Circle Sizes

Major Axis	Minor Axis	
	Max.	Min.
580mm	520mm	430mm
500mm	450mm	360mm
400mm	340mm	250mm
300mm	250mm	160mm
220mm	160mm	160mm
Circle Dia. Min.	160mm	
Circle Dia. Max.	600mm	

Screw Sizes Required

Make and model of suitable routers		Size and quantity of mounting machine screws	Distance between fixing centres	Handle position of router
Trend	T3, T4, T5	M5 x 20 (x2)	50mm	At 90°
AEG	OFE710, OF500S, OF450S	M5 x 20 (x2)	50mm	At 90°
Atlas Copco	OFS50, OFSE850, OFSE1000, OFS720	M5 x 20 (x2)	50mm	At 90°
Black & Decker	BD66	M4 x 20 (x2) + Nut (x2) + Washers (4)	48mm	At 90°
	BD780(E), KW779, KW780(E) KW800(E) SR100	M5 x 20 (x2) + Nut (x2) M5 x 20 (x2)	50mm 50mm	At 90° At 90°
Bosch	POF400A	M6 x 16 (x2)	75mm	In Line
	POF52	M6 x 16 (x2)	75mm	In Line
	POF500A, 600ACE	M6 x 16 (x2)	75mm	In Line
	GOF900A, 900ACE, POF800ACE	M4 x 20 (x2) + Nut (x2) + Washers (x2)	83mm	At 40°
DeWalt	DW613	M5 x 20 (x2) + Nut (x2)	50mm	At 90°
	DW620, 621	M4 x 20 (x2)	74mm	At 60°
Einhell	EOF850SP	M5 x 20 (x2)	50mm	At 90°
Elu	MOF96(E)	M5 x 20 (x2)	50mm	At 90°
	MOF69	M5 x 20 (x2)	50mm	At 90°
	OF97(E)	M4 x 20 (x2)	74mm	At 60°
Festo	OF900(E), 650 1000(E)	M4 x 20 (x2)	65mm	At 20°
Freud	FT1000(E)	M5 x 20 (x2)	74mm	At 60°
Hitachi	FM8	M5 x 20 (x2)	60mm	At 90°
	M8(V)	M5 x 20 (x2)	60mm	At 90°
Holzher	2335, 2336, 2356	M5 x 20 (x2)	50mm	At 90°
Kango	R855OS	M5 x 20 (x2)	50mm	At 90°
Kinzo	25C44	M6 x 16 (2)	72mm	At 90°
Kress	FM6955	M5 x 20 (x2)	50mm	At 90°
Makita	3620	M5 x 20 (x2)	74mm	At 90°
Mafell	LO50E	M5 x 20 (x2)	76mm	At 22.5°
Metabo	OF528, OF1028	M5 x 20 (x2)	65mm	At 90°
	OFE1229	M5 x 20 (x2) + Nut (2)		
Nutool	NPT850	M5 x 20 (x2)	50mm	At 90°
Perles Eurotool	OF808(E)	M5 x 20 (x2)	50mm	At 90°
Peugeot	DEF570E, DF55E	M6 x 16 (x2)	54mm	In Line
		M6 x 16 (x2) + Nut (x2)		
Power Devil	PDW5027	M5 x 20 (x2)	50mm	At 90°
Ryobi	R150, R151, RE155K, RE120	M5 x 20 (x2)	60mm	At 90°
		M6 x 16 (x2) + M6 Nut (x2)	54mm	In Line
Skil*	1835U	No.8 UNF x 3/4" (x3) (not supplied)	Re-drill	N/A
Sparky	X52E	M5 x 20 (x2)	60mm	At 90°
Stayer	PR50	M5 x 20 (x2)	50mm	At 90°
Virutex	FR77C, 78C	M5 x 20 (x2)	50mm	At 90°

*The main plate will require drilling by the user when fitting the Skil router.

OPERATION



Basic Setting Up Procedure

For an Ellipse 480mm x 360mm.

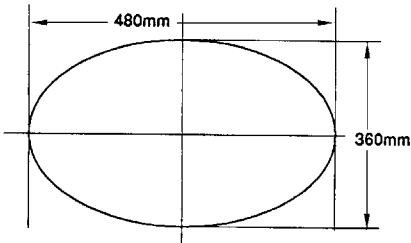

Marking Out

- Determine size of workpiece required.
- Ensure chosen workpiece is sufficiently larger to accommodate the ellipse and support the jig.
- Mark the centre lines for the major and minor axis.
- Mark overall dimensions of ellipse onto centre lines.

Fixing Cross Frame



- Position cross frame using the four sighting marks on the perimeter of the cross frame.
- Drill four 3.2mm (1/8") diameter holes through the holes of the cross frame into the workpiece.
- Using the four mounting screws, fix the cross frame to the workpiece.

Setting Major Axis

- Slide the two sliders into each slot at 90° to each other.
- Locate each of the pivot points over the vertical pin of the slider.
- Loosen both knobs A and B.
- Position the router over major axis mark, slide main frame until cutter is positioned over mark and check that index washer on pivot point 'A' reads 240mm, then lock knob 'A'.



Trial runs should be made on scrap material when first using this jig.



Ensure working position is comfortable and that workbench is at a suitable height.

Illustrations are symbolic and not to scale.

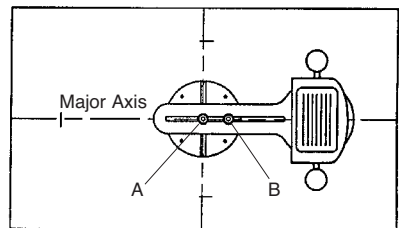
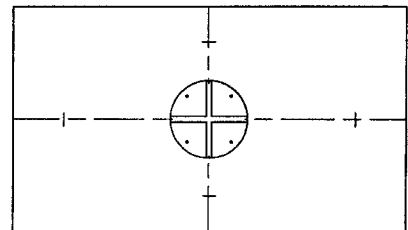
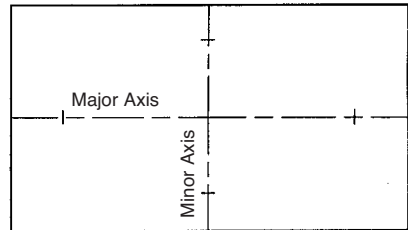

Setting Minor Axis

- Position router cutter over minor axis mark, slide main frame until cutter is positioned over mark and check that index washer on pivot point 'B' reads 180mm, then lock knob 'B'.

Setting up is now complete. Alternatively the positions of the pivot points can be set before locating the pivot points onto the slider pins using the measurement scale. The calculation requires simply halving the major and minor axis and allowing for the cutter diameter.

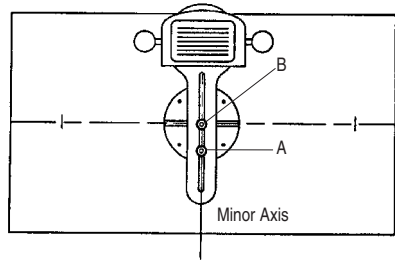

Weakest points & possible poor/rough finish

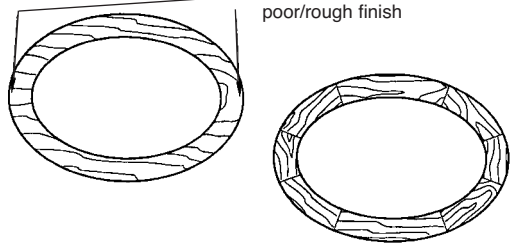

Fixing Methods

The workpiece should be fixed onto a false or waste piece to stop you damaging your work bench.

There are many methods depending on the application as follows:

1. 'G' clamps should be positioned outside the swing area of the jig.
2. Camclamps are ideal as they will not obstruct the jig. An adjustable camclamp jig can be made for various sizes of ellipses.
3. Double-sided tape Ref. DS/TAPE can be used and rolled off easily after operation.
4. Spot gluing with a hot melt glue gun will allow the workpiece to be prized off with minimal surface damage.
5. Panel pins are a quick and easy method providing the small holes are acceptable.

Choice of Material

Whilst it is perfectly possible to produce frames with solid panels of natural wood, there will be a weakness at the short-grained parts of the ellipse. The frame will be delicate and liable to break at these points unless care is taken. A more professional approach is to use a series of mitred jointed sections which overcome the cross-grain problems and give an attractive grained finish. Sections can be dowel or biscuit jointed to give strength to the frame.

Routing Operation

- Fit cutter, switch router on, plunge in and make repeat sweeps with the router at 3mm steps.



When cutting or central panelling, one can reverse direction of feed to stop the electric cable becoming twisted. However, when edge moulding and cutting, feed direction must be opposite to that of the cutter.



Care should be taken on the last cut prior to break through, as the resultant ellipse or circular plaque or ring can possibly move. Double-sided tape can be used to eliminate any danger of this occurring.

- Trial runs should be made on scrap material when first using this jig.

Circle Cutting 

- Fit the circle slider in the centre of the cross frame.
- Screw pin through the slider so that it engages in the hole in the cross frame.
- Adjust the length of the main plate as required for cutting circles from 160mm to 600mm in diameter.
- Fit cutter and rout out the circle.
- After cut is complete, release router plunge and switch off router.

Suitable Cutters & Methods of Working 

Please use Trend original accessories.

Straight Flute Cutter Ref. 3/20L

To cut an elliptical or circular shape, use a narrow two flute straight cutter which is long enough to break-through the material.

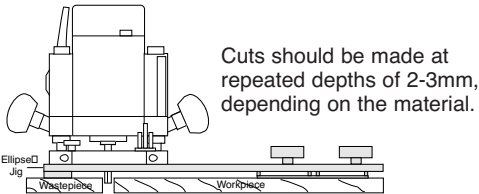

Cuts should be made at repeated depths of 2-3mm, depending on the material.

Guided Ogee Cutter Ref. 46/230

Ideal for moulding the frame or plaque once it has been cut out using the ellipse jig. Best used with the router in a table.

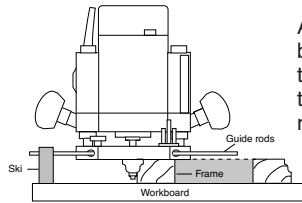
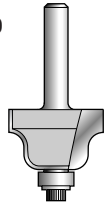

A support pad can be made to prevent the router from tipping over when routing the frame.

Rebate Cutter Ref. 46/39

Used to create the recess for the backing piece and glass. The cutter is supplied with four bearings to allow alternate widths of rebate. Rebate widths of 7.9mm, 9.5mm, 11.1mm and 12.7mm.

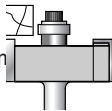

Use in a Router Table

A lead on piece should be used when performing any bearing guided work.

Panelling Cutter Ref. 18/51

Can be used with an elliptical template made on the ellipse jig in conjunction with a guide bush fitted to the router.

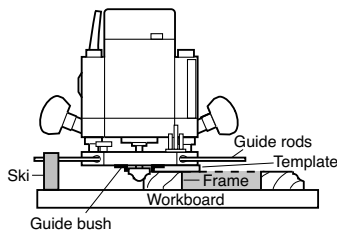
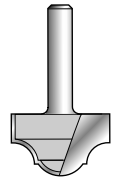

The template is then used to cut and profile the frames in the conventional manner.

Producing a Natural Timber Frame



1.

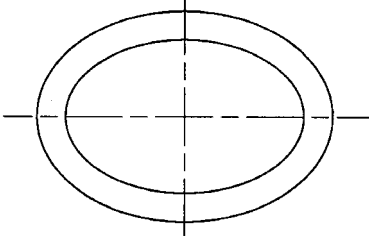

Draw frame onto workboard by fitting plotter pen attachment to the ellipse jig.

2.

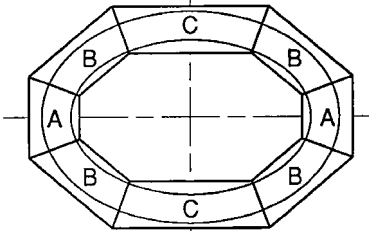

Plan the wood sections to fit the frame allowing enough waste material to support the jig. Calculate the angles and lengths of the sections and cut accurately.

3.

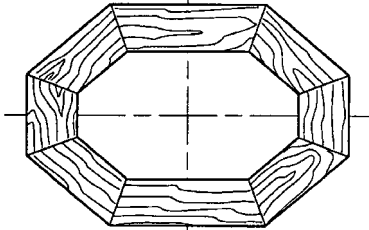

Glue wood sections together to form the frame. Dowel joints can be used for extra strength.

4.

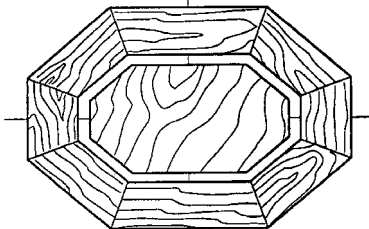

Secure frame to workboard by using double-sided tape or spot hot melt gluing. Fit a scrap piece (the same thickness as the sections) to the centre in the same way.

5.

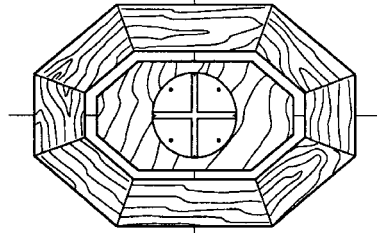

Drill and screw cross frame to the centre of the scrap material.

6.

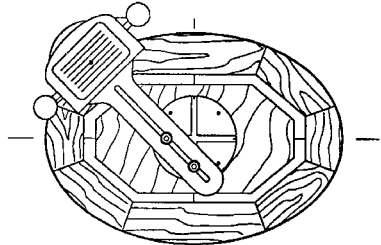

Rout the outside edge of the frame in an anti-clockwise direction at repeated depths of 2-3mm until breakthrough is achieved.

7.

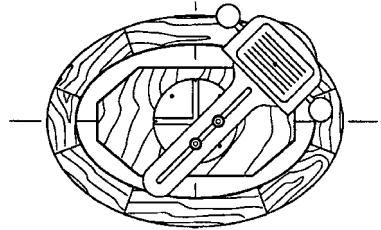

Rout the inside edge of the frame in a clockwise direction at repeated depths of 2-3mm until breakthrough is achieved.

8.

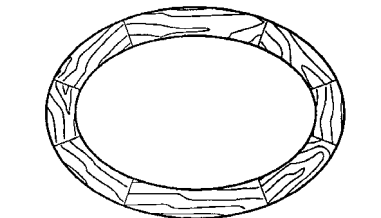

Remove frame from workboard and lightly sand to remove any imperfections that may affect the following stages.

9. Plan

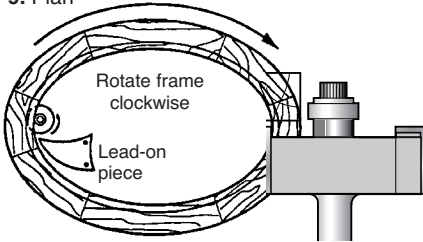

10. Plan

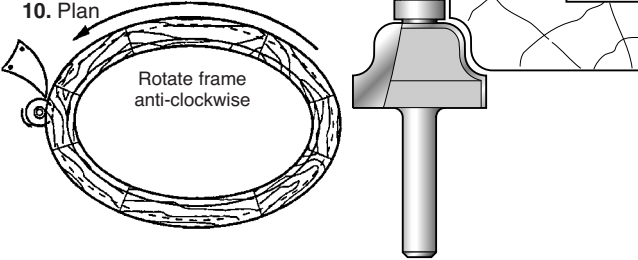

11. Plan

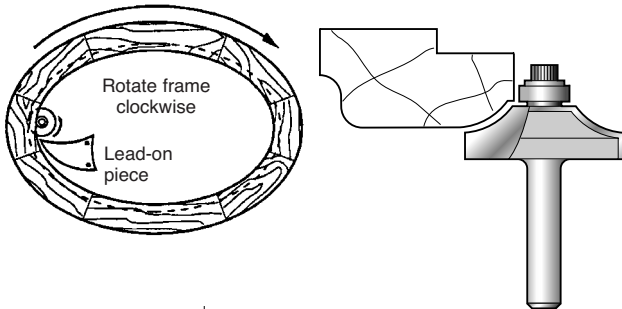

12.

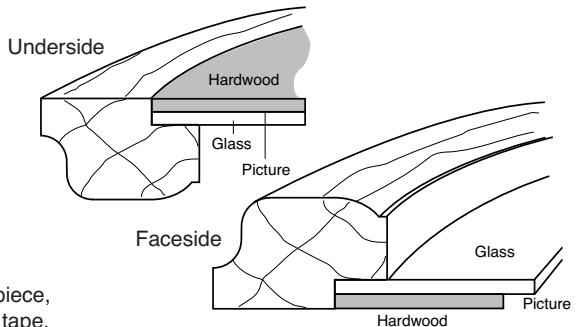
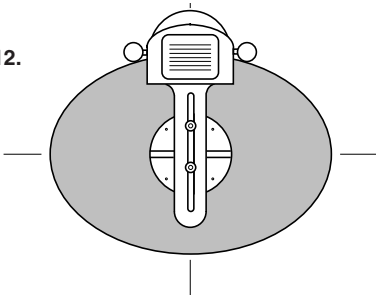

When routing out the backing hardboard piece, secure the cross frame with double-sided tape.

Routing the Rebate on a Router Table Using Ref. 46/39



The rebate for the glass and backing piece can be produced with a bearing guided rebate cutter inverted in a table as shown.

Alternatively, the frame can be left fitted to the work-board as in step 8 and the ellipse jig adjusted so that the correct sized rebate can be made with the same two flute cutter as used to cut the frame.

Routing the Outside Mould on a Router Table Using Ref. 46/230



The moulding of the frame is best suited to a table mounted router fitted with a bearing guided cutter. The frame is inverted with the face side down onto the table. The cutter should be well guarded and the frame rotated against the rotation direction of the cutter.

Two passes at increased depths may be necessary to cut the mould safely.

Routing the Inside Mould on a Router Table Using Ref. 46/41



Repeat the above procedure to rout the outside mould.

Producing an Elliptical Plaque in MDF



This example does not include the use of bearing guided cutters

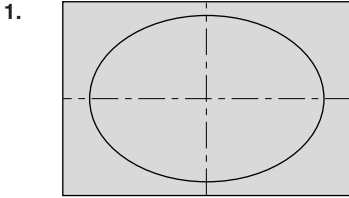

Draw plaque dimensions onto workpiece and clamp to a false baseboard to prevent routing into the workbench. Secure centre area of plaque to baseboard (see clamping section) to prevent plaque from moving when breakthrough is achieved.

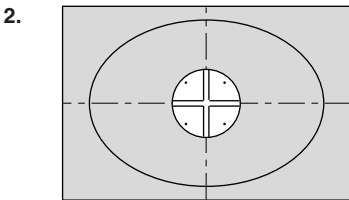

Align the cross frame with the line up notches. It is advisable to secure the cross frame to the workpiece using double-sided tape, this is easily removable and will not damage the workpiece.

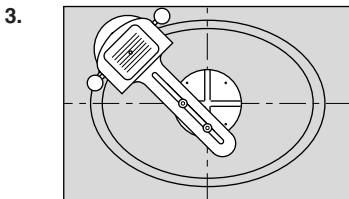

Produce the mould required with a panel type cutter.

Repeated operations can be made with more cutters to achieve a custom design of mould. Adjustment in the size of the ellipse can be made by using the measurement scale on the main plate to adjust both pivot point positions.

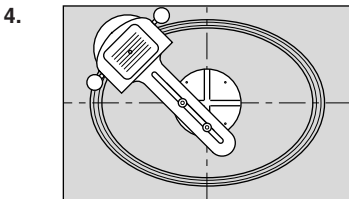
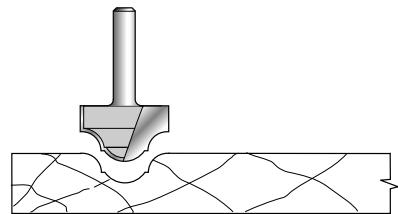

Change the cutter to a straight and take repeated passes until breakthrough is achieved.

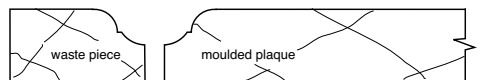

After use remove router from jig and store jig carefully.

MAINTENANCE

Please only use Trend original spares and accessories.

This jig has been designed to operate over a long period of time with a minimum of maintenance. Continual satisfactory operation depends upon proper tool care and regular cleaning.

Cleaning

- Keep the grooves on the main board clear of sawdust.
- Regularly clean the jig with a soft cloth.

Lubrication

- Your jig requires no additional lubrication.

Storage

- This jig should be used and stored at normal room temperature, out of direct sunlight to maintain a smooth operation of the slides.
- After use store jig in its packaging or place in a cupboard.

ENVIRONMENTAL PROTECTION

Recycle raw materials instead of disposing as waste.

Packaging should be sorted for environmental-friendly recycling.

The product and its accessories at the end of its life should be sorted for environmentally friendly recycling.

GUARANTEE

The jig carries a manufacturers guarantee in accordance with the conditions on the enclosed guarantee card.

Please use only Trend original spare parts.

ME/JIG - SPARE PARTS LIST			v3.1 06/2013
Item	Qty.	Desc.	Ref.
1	1	Main Plate	WP-MEJ/1
2	1	Cross Frame	WP-MEJ/2
3	1	Plate Support c/w Pins	WP-MEJ/3
4	2	Index Washer	WP-MEJ/4
5	2	Index Sleeve	WP-MEJ/5
6	2	Ellipse Slider	WP-MEJ/6
7	1	Circle Slider	WP-MEJ/7
8	1	Pencil Plug and Grommet	WP-MEJ/8
10	4	Screw Wood No 8 x 25mm	WP-SCW/100
11	1	Mounting Kit For Router	WP-MEJ/11
12	2	Knob Female M10	WP-MEJ/12
13	1	Manual	MANU/MEJ

ME/JIG - SPARE PARTS DIAGRAM

v3.1 06/2013

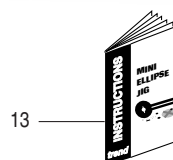
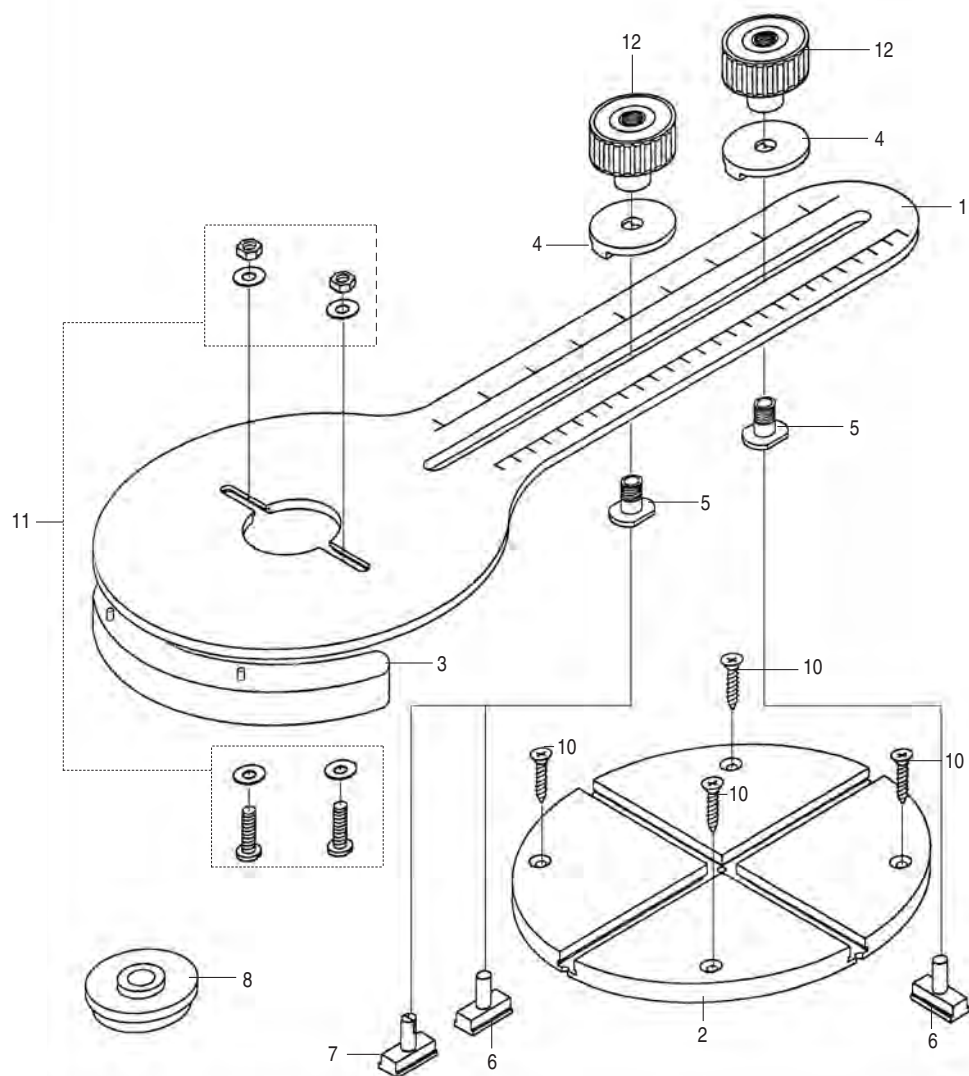

MANU/MEJ v4.0



RECYCLABLE

Trend Machinery & Cutting Tools Ltd.

Odhams Trading Estate St Albans Road

Watford WD24 7TR England

Tel: 0044(0)1923 249911

technical@trendm.co.uk

www.trend-uk.com